

## MAGNETIC FIELD ANALYSIS IN ASYNCHRONOUS MOTORS WITH SIX–PHASE WINDINGS

<sup>1</sup> Technical University of Moldova, Department of Electrical Engineering, Chisinau, Republic of MOLDOVA

**Abstract:** In this paper is presents the results of the magnetic field analysis produced by the two layers stator six–phase windings, of the asynchronous motor for electric traction compared to the three–phase stator winding of mass–produced asynchronous motors. Applying the finite element method, was concretized the shape of the magnetic induction curve in the air gap and the values of magnetic flux and induction for different stator winding schemes were presented. The obtained results give the possibility to select the stator winding scheme, which has technological advantages for the asynchronous motors used in electric traction.

**Keywords:** asynchronous motors, six–phase windings, magnetic induction, electric traction

### 1. INTRODUCTION

In the industrial field, three–phase asynchronous electric machines are becoming more and more widespread. This is due to the construction and operating features, robustness, low cost, minimal maintenance costs and, of course, the efficient control/regulation with the help of electronic frequency converters. [1–4]. Also for these reasons, asynchronous cars are preferably used in the electric traction systems of personal and common passenger vehicles. In order to reduce greenhouse gas emissions, European policies envisage replacing transport units with internal combustion engines with other environmentally clean engines, such as electric motors, by 2050 [1, 5, 6]. Of particular importance is the reliability and energy efficiency of the traction motor, which can be significantly increased by increasing the number of phases of the stator winding [7, 8].

Multiphase electric drives are in the research stage, due to the advantages of multiphase electric machines, thus, analysis and design methods are sought that will improve the performance of these machines [4, 5]. Among the groups of multiphase machines, the six–phase ones attracted more attention due to the simplicity of converting the three–phase machine into a six–phase machine. This is done by two sets of three–phase stator winding, phased between them, having a common magnetic structure.

Multi–phase units are suitable for high power applications as they reduce the phase current to the rated power and phase voltage required. Therefore, multi–phase drives are a promising solution for safety–critical applications, such as autonomous electric propulsion [9].

The implementation of multiphase electrical drives in the field of electric transport has become necessary because, in addition to the fact that it offers superior advantages over three–phase ones, the uncontrolled activity of businesses, power plants and transportation, leads to excessive environmental pollution and the appearance of smog in large cities that are harmful to nature and general health.

### 2. PARTICULARS OF SIX–PHASE ASYNCHRONOUS MOTORS

This paper presents the study of the magnetic field distribution in the asynchronous six–phase motor, intended for operation in adjustable electric drives, powered by the six–phase inverter. The construction of six–phase asynchronous motors is based on standard three–phase machines except for the stator winding.

The stator winding can be performed from a double three–phase winding, where one winding is shifted from the other at an angle of  $\gamma = 0$  electrical degrees, of two asymmetrical three–phase windings shifted from the other at an angle  $\gamma = 30$  electrical degrees, or from two symmetrical three–phase windings shifted from the other at an angle  $\gamma = 60$  electrical degrees, as shown in Figure 1.

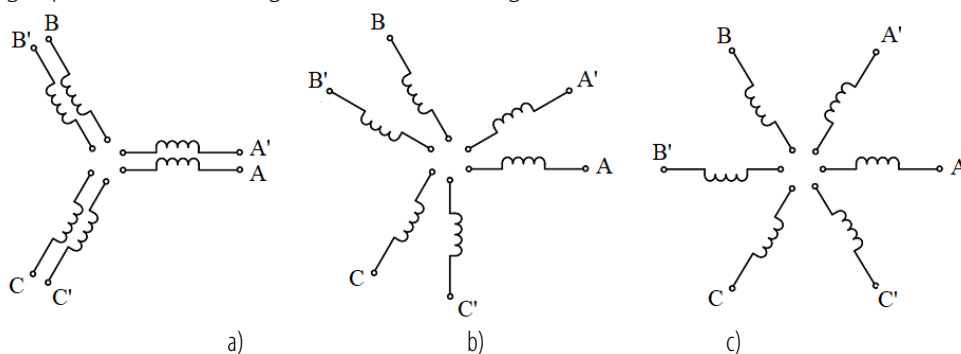

Figure 1. Six–phase asynchronous machine windings: a) double three–phase winding ( $\gamma = 0^\circ$ );  
b) asymmetrical six–phase windings ( $\gamma = 30^\circ$ ); c) symmetrical six–phase windings ( $\gamma = 60^\circ$ )

The aim of this paper is to analyze the constructive specificity of the six-phase windings of asynchronous motors and the magnetic field distribution produced by the currents of these windings. For this, the values of the phase currents were determined mathematically, based on which the magnetizing forces acting in the air gap were subsequently determined. The following are proposed the three-phase and six-phase winding diagrams of the asynchronous motor with power  $P_n = 2,2$  kW,  $U_{1n} = 380$  V voltage, frequency  $f = 50$ Hz,  $2p = 6$ . The winding schemes are given for a pair of poles, the others being analog (Figure 2). The winding is mounted in two layers.

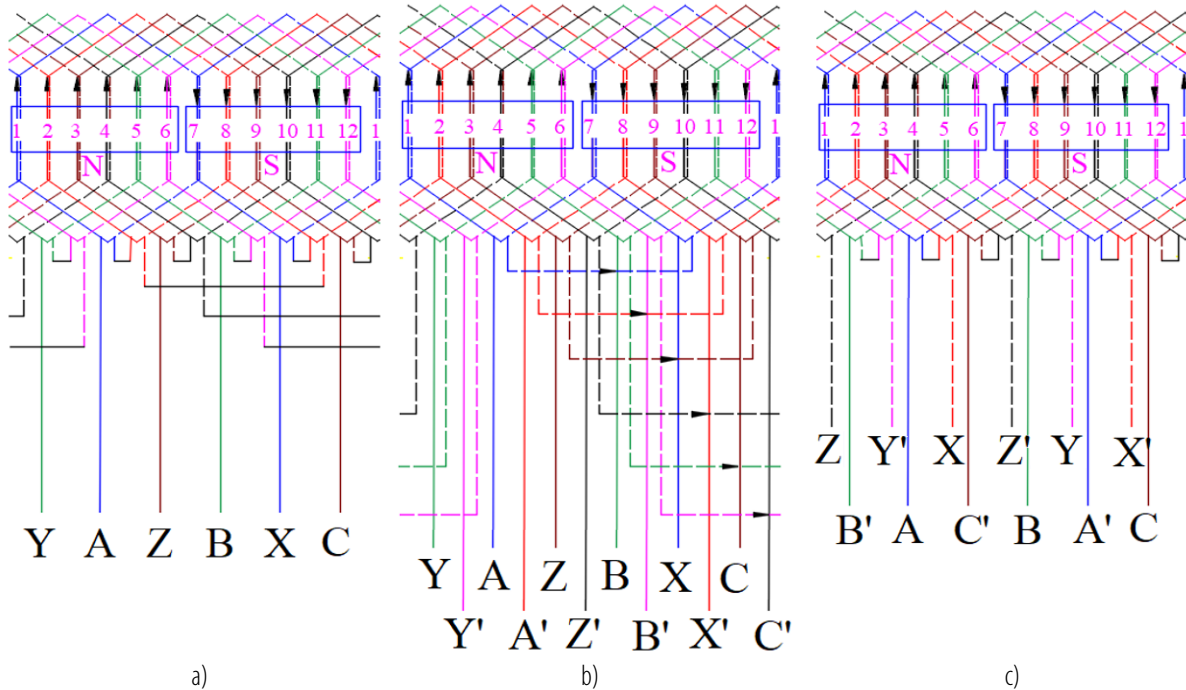

Figure 2. 36-notch asynchronous motor winding diagrams

a) three-phase winding; b) asymmetrical six-phase windings; c) symmetrical six-phase windings

The number of notches for a phase and a pole  $q$  is determined by the expression

$$q = \frac{Z_1}{2 \cdot p \cdot m_1} \quad (1)$$

Finally, for the three-phase winding, choose  $q = 2$  neighboring notches, called shower notches in which the current will have the same direction through the coils, and for the six-phase winding, choose  $q = 1$ .

### 3. MAGNETIC FIELD ANALYSIS OF THE MAGNETIC CIRCUIT

The mathematical description of the magnetic field is made with the Maxwell equations. This system of equations is acceptable for the magnetic field description in electric machines, in which case the known assumptions are adopted.

The equations used to describe the stationary magnetic field are given as follows:

$$\text{rot } \vec{H} = \vec{I}_{st}, \quad \text{div } \vec{B} = 0 \quad (2)$$

$$\text{rot } \vec{H} = \vec{I}_{st} + \vec{I}_d, \quad \text{rot } E = \frac{\partial \vec{B}}{\partial t} \quad (3)$$

The time-varying electromagnetic field is described by the equations:

$$\text{div } \vec{B} = 0, \quad \vec{B} = \mu \vec{H}, \quad \vec{I}_d = jE \quad (4)$$

The quantitative assessment of the electromagnetic field is determined by the intensity of the electric field  $E$  and magnetic tension  $\vec{H}$  or magnetic induction  $\vec{B}$ .

The calculation of the electromagnetic field comes down to determining these quantities. The solution of the problems related to the calculations of the magnetic field is obviously simplified, being introduced the auxiliary functions of the scalar and vectorial potential.

The scalar potential satisfies the requirements of equality

$$\vec{H} = \text{grad} \phi_m \quad (5)$$

or

$$\text{div grad} \phi_m = 0$$

In electric machines, in most engineering problems, the magnetic field is considered constant in the z-axis direction and then

$$\frac{\partial^2 \varphi_m}{\partial^2 x} + \frac{\partial \varphi_m}{\partial y^2} = 0 \quad (6)$$

and the equation for magnetic field lines

$$\frac{\partial x}{H_x} + \frac{\partial y}{H_y} \text{ or } H_y \partial x = H_x \partial y. \quad (7)$$

According to (5) the magnetic tension lines are orthogonal to the equipotential lines. This conclusion plays an important role in determining the boundary conditions between two environments with different permeability  $\mu$ .

The second additional function by which both the potential and the solenoid magnetic field can be determined is the potential vector.  $\vec{A}$ . For the two-dimensional magnetic field present in electric machines, the components of the magnetic induction vector along the X and Y-axis are determined by the equations:

$$B_y = -\frac{\partial A_z}{\partial x}; \quad B_x = \frac{\partial A_z}{\partial y}.$$

All the lines with constant magnetic potential, construct with a certain step of modification the values of the potential vector, being thus determined systematically the picture of the magnetic field in the given plane. The magnetic field chart determines the intensity of the magnetic flux in the given range of the magnetic circuit. This method is extremely advantageous in terms of the time taken to solve the problem. In addition, the method is accurate in calculations and is universal.

Currently, there are methods for calculating the magnetic field in electric machines that allow you to delve into the physics of electromagnetic processes much deeper, being discovered and confirmed the logical conception underlying the theory of electric machines.

With the help of the finite element method, two sides of the essence of the magnetic field can be determined and calculated qualitatively and quantitatively: distribution of magnetic induction lines, well the picture of the magnetic field in the electric machine and the magnetic induction distribution curve in any cross section of the magnetic circuit [6].

Next, using the FEMM software, the distribution of the magnetic field overall circuit of the magnetic system is presented.

Figure 3 shows the currents of the three-phase winding of the asynchronous motor, which produce the magnetic field, the picture of which is shown in Figure 4. The picture shows the uniform distribution of the magnetic field overall magnetic circuit of the six poles.

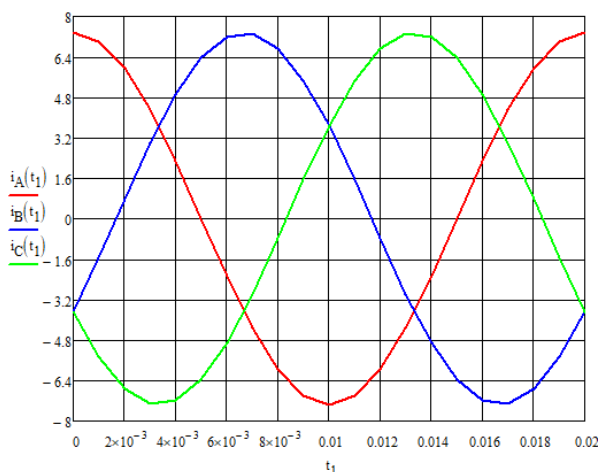

Figure 3. Three-phase current diagram

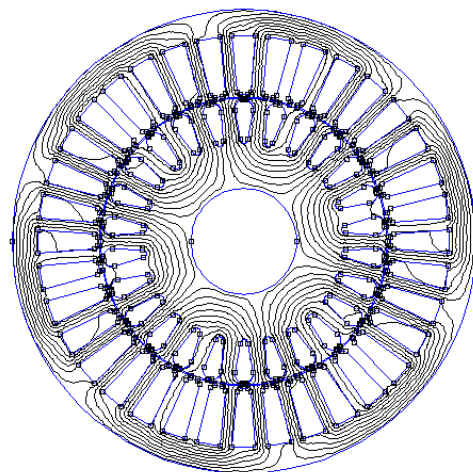

Figure 4. Magnetic field picture of three-phase asynchronous motor

The FEMM program allows the visualization of the values of magnetic induction and other parameters of the magnetic circuit. Figure 5 shows a sector of the stator magnetic circuit and the values of the induction and magnetic flux. These values will be compared with the values obtained by simulating the six-phase asynchronous motor with the symmetrically and asymmetrically mounted winding.

The distribution of magnetic induction in the air gap of the asynchronous motor is shown in Figure 6.

Below are the results of the asynchronous motor simulation with different six-phase windings.

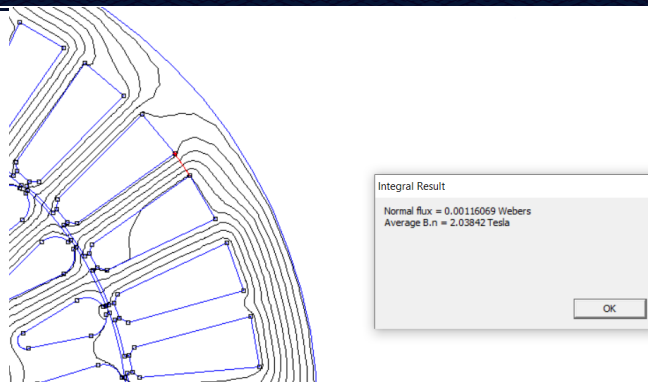

Figure 5. Data table for induction and magnetic flux in the stator dental area

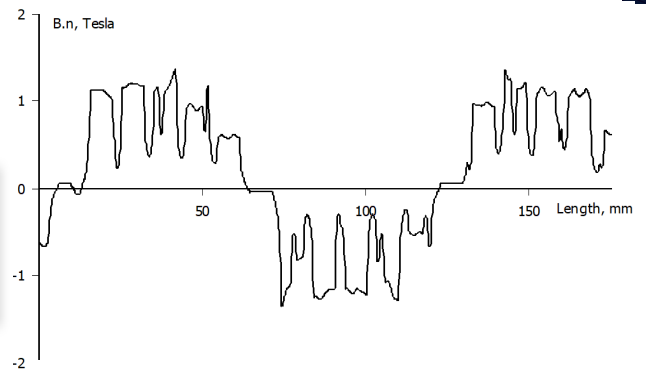

Figure 6. Magnetic induction curve in the air gap of the three-phase asynchronous motor

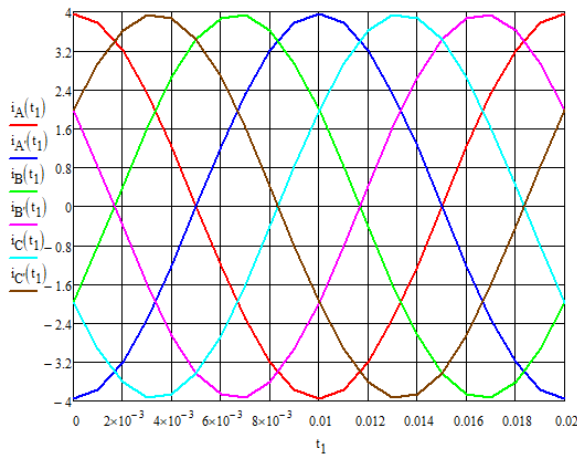

Figure 7. Diagram of winding currents with six symmetrically mounted phases

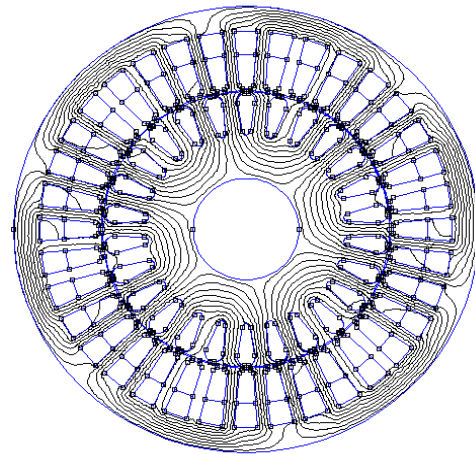

Figure 8. Symmetrical six-phase asynchronous motor magnetic field picture

Figure 7 shows the six-phase winding currents mounted symmetrically in the stator notches of the asynchronous motor, which produce the magnetic field, the picture of which is shown in Figure 8. Figure 9 shows a stator magnetic circuit sector and the induction and magnetic flux values in the dental area. Figure 10 shows the magnetic induction curve in the air gap of the electric machine.

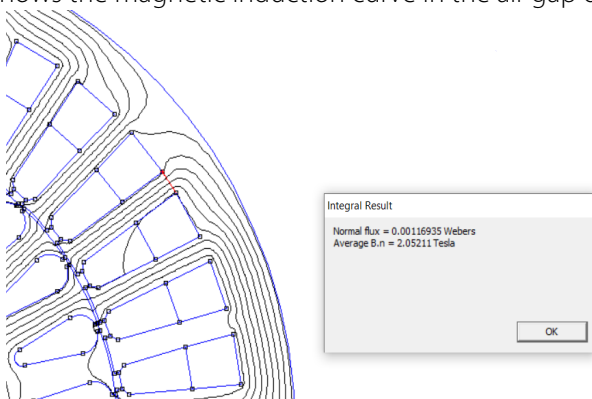

Figure 9. Data table for induction and magnetic flux in the stator dental area

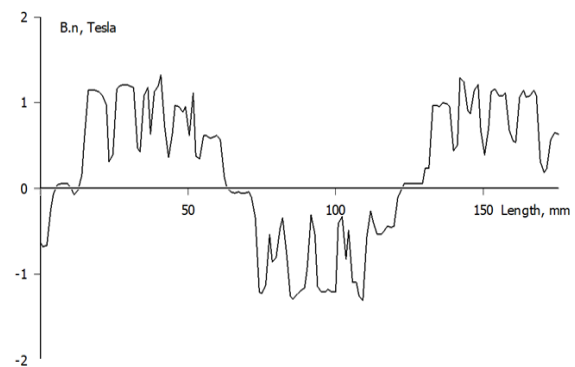

Figure 10. Magnetic induction curve in the air gap of the asynchronous six-phase motor mounted symmetrically

Figure 11 shows the six-phase winding currents mounted asymmetrically in the stator notches of the asynchronous motor, which produce the magnetic field, the picture of which is shown in Figure 12.

Figure 13 shows a stator magnetic circuit sector and the induction and magnetic flux values in the dental area of the asynchronous motor with the asymmetrically mounted six-phase windings.

Figure 14 shows the magnetic induction curve in the air gap of the asynchronous motor with the asymmetrically mounted six-phase windings.

To analyze the indicators of the parameters of the winding under study, the result of superimposing the curves of electromagnetic induction in the air gap for the cases of symmetrical and asymmetrical installation of the stator winding with six phases and three-phase winding is given (Figure 15).

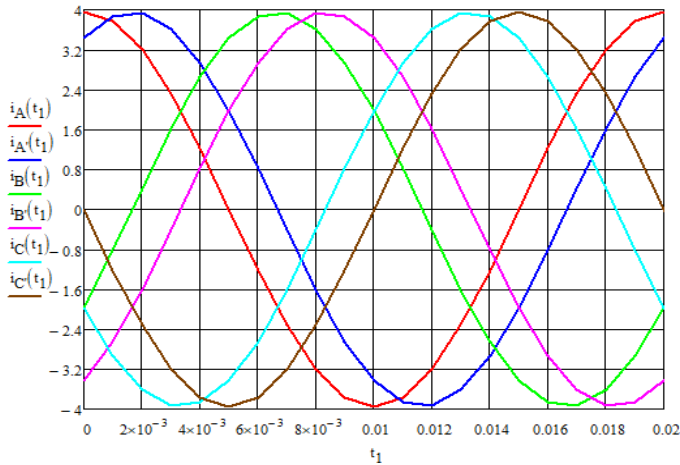

Figure 11. Diagram of winding currents with six asymmetrically mounted phases

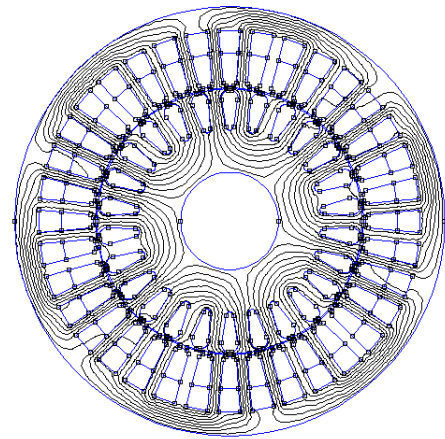

Figure 12. Asymmetrical six-phase asynchronous motor magnetic field picture.

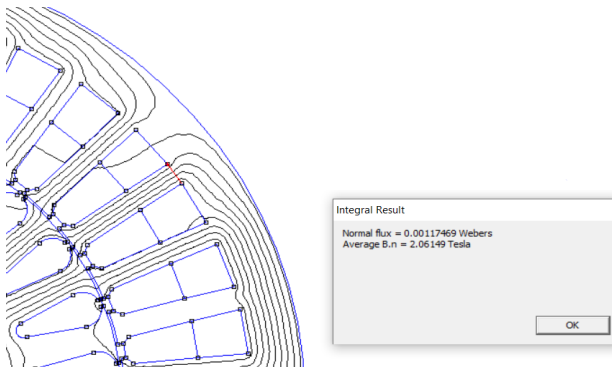

Figure 13. Data table for induction and magnetic flux in the stator dental area.

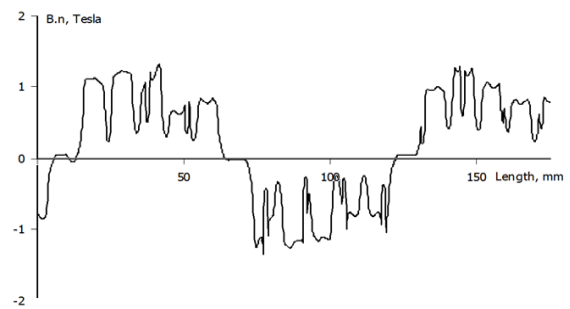

Figure 14. Magnetic induction curve in the air gap of the asynchronous six-phase motor mounted asymmetrically

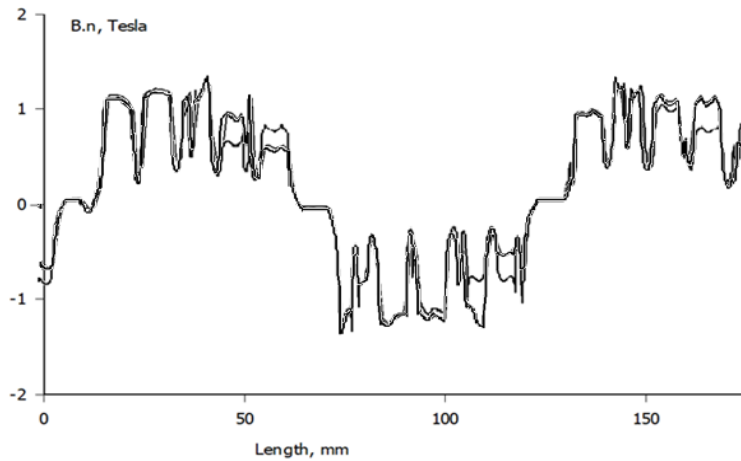

Figure 15. The result of the superposition of the magnetic induction curves in the air gap of the three-phase and six-phase asymmetric and asymmetric asynchronous motor

Figure 15 shows that the magnetic induction curve for different types of windings used in the construction of the asynchronous motor is practically identical, with small variations for the case of the six-phase winding mounted asymmetrically. The values of magnetic induction and magnetic flux in the stator dental area are approximately equal, which shows that the magnetic field does not change at the same position of the poles formed by different winding schemes. Thus, we can claim that the stator-winding scheme, mounted in two layers, for asynchronous six-phase motors can be chosen depending on the power of the asynchronous motor and the advantage, from a technological point of view.

#### 4. CONCLUSIONS

Were analyzed six-phase winding schemes in two layers of the asynchronous motor compared to the three-phase winding of the mass-produced asynchronous motor.

With the help of FEMM software, the magnetic field produced by the analyzed windings of the asynchronous motor was studied and the values and curves of the variation of fluxes and magnetic induction in certain areas

of interest of the magnetic circuit were obtained. The values of magnetic induction for all types of stator winding schemes analyzed do not differ significantly.

The results show that for six-phase asynchronous motors we can choose the technologically advantageous two-layer-winding scheme.

#### Acknowledgement

This paper was developed in support of the ELTRAC project 20.80009.5007.29PS "Integrated domestic electric traction systems for urban passenger vehicles".

**Note:** This paper was presented at CNAE 2022 – XX<sup>th</sup> National Conference of Electric Drives, organized by University POLITEHNICA Timisoara, Faculty of Faculty of Electrotechnics and Electroenergetics (ROMANIA), in Timisoara, ROMANIA, in 12–13 May, 2022.

#### References

- [1] R. Gregor, F. Barrero, S. Toral and M.J. Durán „Realization of an Asynchronous Six-Phase Induction Motor Drive Test-Rig”. RE&PQJ, Vol. 1, No.6, March 2008. <https://doi.org/10.24084/repqj06.230>;
- [2] Ilie Nuca, Vadim Cazac, Adrian Turcanu, Marcel Burduniuc „Development of Traction System with Six Phase Induction Motor for Urban Passenger Vehicle”. 2020 International Conference and Exposition on Electrical And Power Engineering (EPE), 22–23 october 2020 Iasi, Romania, Electronic ISBN: 978–1–7281–8126–4. DOI: 10.1109/EPE50722.2020.9305555. <https://ieeexplore.ieee.org/document/9305555>;
- [3] G. K. Singh, “Multi-Phase Induction Machine Drive Research – a Survey”, Electric Power Systems Res., Vol. 62, 2002, pp.139–147;
- [4] Petru Todos, Ghenadie Terteia, Ilie Nuca, Vadim Cazac, Marcel Burduniuc „Acceptance Testing of the Six-Phase Asynchronous Machines”. 13th International Conference on Electromechanical and Energy System – SIELMEN 2021, 6–8 october 2021, Iasi – Chisinau. Electronic ISBN:978–1–6654–0078–7. DOI: 10.1109/SIELMEN53755.2021.9600412. <https://ieeexplore.ieee.org/document/9600412>;
- [5] Ilie Nuca, Dusan Kostic, Petre–Marian Nicolae, Ilie Nuca, Vadim Cazac, Marcel Burduniuc „Harmonic Decomposition and Power Quality Analysis of a Six-Phase Induction Motor Traction Drive with Fast Fourier Transform”. 13th International Conference on Electromechanical and Energy System – SIELMEN 2021, 6–8 october 2021, Iasi – Chisinau. Electronic ISBN:978–1–6654–0078–7. DOI: 10.1109/SIELMEN53755.2021.9600295. <https://ieeexplore.ieee.org/document/9600295>;
- [6] Tudor Ambros, Marcel Burduniuc „The Magnetic Field of Asynchronous Machines with Concentrated Winding” 2016 International Conference and Exposition on Electrical and Power Engineering, October 20–22, 2016 Faculty of Electrical Engineering, Iasi, Romania, Electronic ISBN: 978–1–5090–6129–7, p. 161–164;
- [7] M. Slunjski, O. Djordjevic, M. Jones and E. Levi, „Symmetrical/asymmetrical winding reconfiguration in multiphase machines”, in IEEE Access, vol. 8, pp. 12835–12844, 2020;
- [8] Lelisa Wogji, Amruth Thelkar, Tesfabirhan Tahiro, Tadele Ayana, Shabana Urooj and Samia Laguech „Particle Swarm Optimization Based Optimal Design of Six-Phase Induction Motor for Electric Propulsion of Submarines” Energies 2022, 15, 2994. <https://doi.org/10.3390/en15092994>;
- [9] Alexandru Tarlajanu „Development of Vector Control Structures for Traction Systems with Six-Phase Asynchronous Motors”. 13th International Conference on Electromechanical and Energy System – SIELMEN 2021, 6–8 october 2021, Iasi – Chisinau. Electronic ISBN:978–1–6654–0078–7. DOI: 10.1109/SIELMEN53755.2021.9600403. <https://ieeexplore.ieee.org/document/9600403>.



ISSN 1584 – 2665 (printed version); ISSN 2601 – 2332 (online); ISSN–L 1584 – 2665

copyright © University POLITEHNICA Timisoara, Faculty of Engineering Hunedoara,

5, Revolutiei, 331128, Hunedoara, ROMANIA

<http://annals.fih.upt.ro>