

# THE STARTING OF SINGLE-PHASE INDUCTION ENGINE, PHYSICAL PROCESSES AND THEORETICAL PREMISES

Lecturer Eng. Marcel BURDUNIUC<sup>1</sup>

<sup>1</sup>Technical University of Moldova

**REZUMAT.** Se constată utilizarea eficientă a motorului asincron pentru mecanismele și mașinile cu pornirea în gol și cuplul de pornire redus. Pe stator este prevăzută o singură înfășurare divizată, la pornire, în două părți, cu numărul de spire care diferă de (3-4) ori. Parametrii părților respective (rezistențele și reactanțele) se deosebesc esențial, astfel fiind asigurată pornirea motorului. În lucrare sunt prezentate elemente de teorie referitoare la aceste motoare. Rezultatele obținute s-au confirmat folosind metoda elementelor finite la determinarea câmpului magnetic.

**Cuvinte cheie:** motor asincron, înfășurare divizată, câmp magnetic, defazaj, rotor scurtcircuitat.

**ABSTRACT.** There is revealed an effective use of asynchronous engine for mechanisms and machines that are running idle and reduced starting torque. The stator is equipped with a single winding divided, on startup, in the two parts, with the number of coils which differ by (3-4) times. The parameters of respective parties (resistances and inductances) differ essentially, thus insuring the engine startup. The paper presents theory elements referring to these engines. The obtained results have been confirmed using the finite elements method in determining the magnetic field.

**Keywords:** induction engine, divided winding, magnetic field, phase shift, shortcircuit rotor.

## 1. INTRODUCTION

The main disadvantage of single-phase asynchronous engines without auxiliary winding is the lack of the starting torque. There are known various methods, based on the phase shift of the starting and running winding currents, in order to ensure the startup of these engines [1, 2]. The startup ensured by inductive character of phase shift between phases is used for mechanisms with low starting torque, for the most parts of it. It is necessary an auxiliary winding with the number of coils much higher than the number of coils of the running winding in this case. Thus, a phase shift between the running and auxiliary winding currents are obtained, which assure the engine run. The basic disadvantage of this method is the fact that the auxiliary winding is connected to the network only during engine start being calculated at a current density ten times higher than that of the running winding. In the normal operation of engine the auxiliary winding is not participating in the production of the useful torque.

## 2. PHYSICAL PROCESSES AND THEORY ELEMENTS

Further the electric diagram of the single-phase

asynchronous engine's winding (MASF) is analyzed, which excludes this disadvantage [3].

Figure 1 shows the principle scheme of this MASF. A toroidal winding  $W_{Ax}$  is placed on the stator, divided into two parts. Both sides of the stator winding  $W_{1Ax}$  and  $W'_{1Ax}$  contain the coils  $W_{2By}$  and  $W'_{2By}$ , which are short circuited in the start process with the breaker  $k$ .

This breaker may be a thermal element, which is

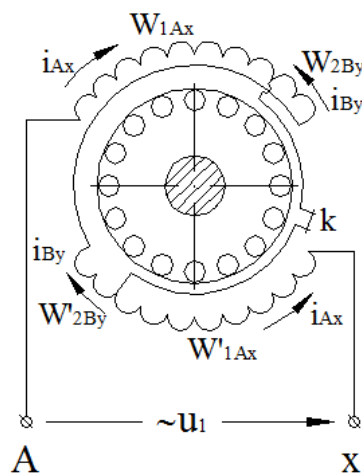

Fig. 1. The principal scheme of the single-phase asynchronous motor with the asymmetrical stator winding

heating and open the circuit for large values of shortcut current, thus the coils  $W_{2By}$  and  $W'_{2By}$  are connected in series with the coils  $W_{1Ax}$  and  $W'_{1Ax}$ .

The short circuit current  $I_{By}$ , which is closed through the  $W_{2By}$  and  $W'_{2By}$  coils, is much higher than the  $I_{Ax}$  current in the start process, witch is closed through the  $W_{1Ax}$  and  $W'_{1Ax}$  coils, because the number of  $W_{2By}$  and  $W'_{2By}$  coilings constitutes approximately (10-25)% of the number of  $W_{1Ax}$  and  $W'_{1Ax}$  coils. Due to gap equal to the  $\alpha$  angle between principal coil  $B_{Ax}$  and shortcuted coil  $B_{By}$  of the single-phase winding, the gap between the fluxes produced by those 2 pairs of coils is assured (fig. 2). Due to the different values of inductance and resistance of two pairs of coils, which are materialized through different values of their impedance the phase shift between  $I_{Ax}$  and  $I_{By}$

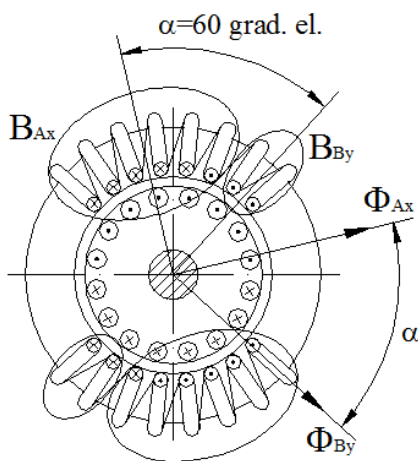

Fig. 2. The gap between the principal and the shorted coils axis

currents is ensured.

The magnetizing forces produced by stator currents create asymmetry in the magnetic circuit. The fluxes produced by these magnetizing forces create the starting torque of the asynchronous single-phase engine by interacting with rotor currents.

The phase shift between the divided winding currents, which ensures the engine start, is achieved by shortcuting the part  $W_{2By}$  and  $W'_{2By}$  of the basic winding  $W_{1Ax}$  and  $W'_{1Ax}$ . This one remains connected in series with the winding  $W_{1Ax}$  and respectively  $W'_{1Ax}$  after start, by opening the contact k, by which the

part of starting winding  $W_{2By}$  and  $W'_{2By}$  was shortcuted, contributing to the nominal regime functioning of the single-phase asynchronous engine. The useful torque is produced, therefore, by the whole stator winding.

The single-phase asynchronous motor with a single stator winding has the rotor winding with shortcuted bars, while in  $\frac{2}{3}$  of the stator notches a winding is mounted (fig. 3). The toroidal winding is divided into two diametrically opposite parts, each of part containing  $\frac{1}{3}Z_1N_c$  conductors, grouped in  $\frac{1}{3}Z_1$  coils. Each of group of coils is divided, in turn, into two coil subgroups: the first subgroup containing  $\frac{1}{4}Z_1$  coils, and the second one  $\frac{1}{12}Z_1$  coils. The placement of these two coil subgroups is symmetric with the rotational axis.

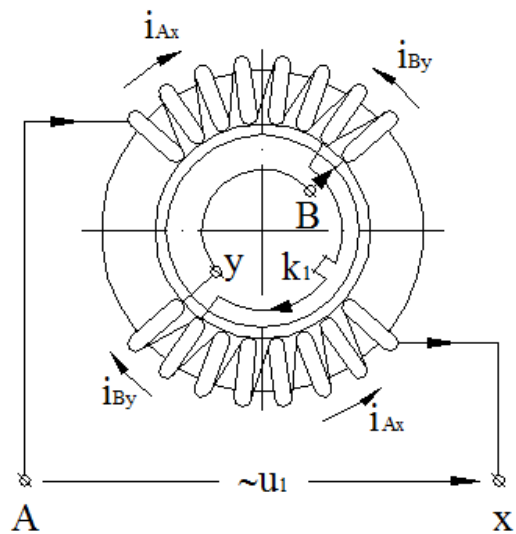

Fig. 3. The distribution of coils in the notches

Number of notches incumbent stator winding Ax, with the two parts  $W_{1Ax}$  and  $W'_{1Ax}$  is the:

$$Z_{Ax} = \frac{2}{3}Z_1 \quad (1)$$

The number of notches incumbent on the stator winding Ax with the two parts  $W_{1Ax}$  or  $W'_{1Ax}$  :

$$Z_{1Ax} = \frac{1}{2}Z_1 \quad (2)$$

The umber of notches incumbent on the shortcuted winding  $W_{2By} + W'_{2By}$  is:

$$Z_{By} = \frac{1}{6} Z_1 \quad (3)$$

Then, the number of notches which belong to the part  $W_{2By}$  or  $W'_{2By}$  is

$$Z_{1By} = \frac{1}{2} Z_{By} \quad (4)$$

The angle corresponding to a part of the  $W_{Ax}$  winding is determined as:  
for  $Ax$  phase

$$\gamma_{1Ax} = \frac{360}{Z_1} \cdot \frac{1}{2} \cdot \frac{Z_1}{2} \quad (5)$$

for  $By$  phase

$$\gamma_{1By} = \frac{360}{Z_1} \cdot \frac{1}{6} \cdot \frac{Z_1}{2} \quad (6)$$

As a result, the axes of magnetic fluxes are spatially shifted by an angle

$$\frac{\gamma_{1Ax} + \gamma_{1By}}{2} \quad (7)$$

### 3. ELECTROMOTIVE VOLTAGES INDUCED IN WINDING

The stator winding has the diametral step

$$y_A = \frac{Z_1}{2p} \quad (8)$$

The  $By$  winding is, also, distributed into notches and has the diametral step  $y_B = 12$ .

The number of notches for one phase and one pole in the case of  $Ax$  winding is:

$$q_A = \frac{Z_{Ax}}{2pm} \quad (9),$$

and for  $By$  winding

$$q_B = \frac{Z_{By}}{2pm} \quad (10).$$

Then, the distribution coefficient for  $W_{1Ax}$  phase is:

$$k_{qA} = \frac{\sin q_A \cdot \frac{\gamma}{2}}{q_A \sin \frac{\gamma}{2}} \quad (11),$$

And the distribution coefficient for  $W_{1By}$  phase is:

$$k_{qB} = \frac{\sin q_B \cdot \frac{\gamma}{2}}{q_B \sin \frac{\gamma}{2}} \quad (12).$$

The winding coefficients for both parts of the winding are calculated as:

$$\begin{aligned} k_{W1Ax} &= k_{sA} \cdot k_{qA} \\ k_{W1By} &= k_{sB} \cdot k_{qB} \end{aligned} \quad (13)$$

The  $Ax$  winding is connected to the network at engine start, and the breaker  $k$  is shortcuted by  $By$  winding. The electromotive voltage with the effective value

$$E_{W1Ax} = \pi \cdot \sqrt{2} \cdot \Phi_m \cdot f_1 \cdot W_{1Ax} \cdot k_{W1Ax} \quad (14)$$

is induced in  $W_{1Ax}$  winding and in the  $By$  winding the electromotive voltage is:

$$E_{W1By} = \pi \cdot \sqrt{2} \cdot \Phi_m \cdot f_1 \cdot W_{By} \cdot k_{W1By} \quad (15).$$

### 4. DETERMINATION OF MAGNETIZING FORCES

Two spatially shifted phases with an angle of 60 electrical degrees are mounted on the stator in the starting process of single-phase asynchronous engine (fig. 2). It is, also, admitted that the phase currents are shifted in time by the same angle of 60 degrees. It is known that the number of coilings of one section of the toroidal winding is:

$$W_s = \frac{W_{it}}{2} \quad (16)$$

Two ring coils 1 and 2 form a section with two sides placed in the notches of the stator with winding step  $y_A$  (fig. 4)

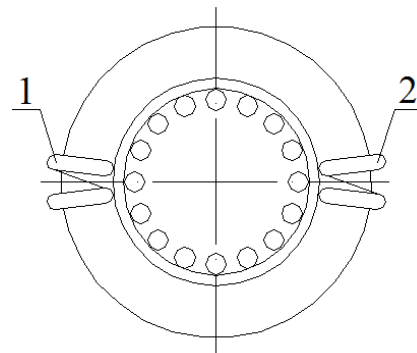

**Fig. 4.** The mounting scheme of coils 1 and 2

The amplitude of magnetizing force of the  $W_{1Ax}$

phase section is:

$$F_{\max 1} = \frac{4}{\pi} \cdot \frac{I_{m1Ax} \cdot W_{it}}{2} = 0,9 I_{1Ax} W_{it} \quad (17)$$

The magnetizing force of  $q_{Ax}$  sections group is:

$$F_{\max 1} = q_A \cdot F_{mit} \cdot k_{qA}, \quad (18)$$

where  $k_{qA}$  – the distribution coefficient of the sections.

If the phase has  $q$  sections and, respectively,  $p$  poles and  $W_{1Ax}$  coils, then

$$F_{m1Ax} = \frac{4}{\pi} \cdot \frac{q_A \cdot W_{1Ax} \cdot k_{qA}}{2p} \cdot I_{m1Ax}. \quad (19)$$

Similar will be for the  $B_y$  phase:

$$F_{m1By} = 0,9 I_{By} \frac{W_{By} \cdot k_{W1By}}{p} \quad (20)$$

## 5. DECOMPOSITION OF MAGNETIZING FORCES

We admit that the amplitudes of the magnetizing forces of both sides of the stator winding are equal and the angle between them constitutes 60 degrees, but the magnetizing forces of the both sides of the stator winding are equal.

The expression of magnetizing force equation can be written as:

$$F_{t1Ax} = F_m \cdot \cos \omega_1 t \cdot \cos \frac{x\pi}{\tau} \quad (21)$$

$$F_{t1By} = F_m \cdot \cos \left( \omega_1 t - \frac{\pi}{3} \right) \cdot \cos \left( \frac{x\pi}{\tau} - \frac{\pi}{3} \right)$$

Decomposing these equations we obtain:

$$\begin{aligned} F_{1Ax} &= 0,5 F_{m1Ax} \cdot \cos \left( \omega_1 t - \frac{x\pi}{\tau} \right) + \\ &+ 0,5 F_{m1Ax} \cos \left( \omega_1 t + \frac{x\pi}{\tau} \right) \\ F_{1By} &= 0,5 F_{m1Ax} \cdot \cos \left( \omega_1 t - \frac{\pi}{3} - \frac{x\pi}{\tau} + \frac{\pi}{3} \right) + \\ &+ 0,5 F_{m1Ax} \cos \left( \omega_1 t - \frac{\pi}{3} + \frac{x\pi}{\tau} - \frac{\pi}{3} \right) \\ F_{1By} &= 0,5 F_{m1Ax} \cdot \cos \left( \omega_1 t - \frac{x\pi}{\tau} \right) + \\ &+ 0,5 F_{m1Ax} \cos \left( \omega_1 t + \frac{x\pi}{\tau} - \frac{2\pi}{3} \right) \end{aligned} \quad (22)$$

We obtain another expression for the terms with the same phase (direct) by adding the terms from the right part of the expressions:

$$F_{mABd} = F_{m1} \cos \left( \omega_1 t - \frac{x\pi}{\tau} \right), \quad (23)$$

where we obtain:

$$F_{mABd} = F_{m1} \cos(-\pi) = F_{m1} \quad (24)$$

for  $t = 0$  and  $x = \tau$  and we obtain the expression for inversed  $F_m$  for the terms shifted by 120 electrical degrees,

$$\begin{aligned} F_{mABi} &= 0,5 F_{m1} \left[ \cos \left( \omega_1 t + \frac{x\pi}{\tau} \right) + \cos \left( \omega_1 t + \frac{x\pi}{\tau} - \frac{2\pi}{3} \right) \right] \\ &= 0,5 F_{m1} \left[ \cos \pi + \cos \left( \pi - \frac{2\pi}{3} \right) \right] = -0,25 F_{m1} \end{aligned} \quad (25)$$

The phasor of the magnetizing force describes an ellipse with direct amplitude equal to the amplitude  $F_m$  of the phase. The phasor of the inversed magnetizing force constitutes 25% of the  $F_m$  phase amplitude and, of course, is rotating with the same angular speed in

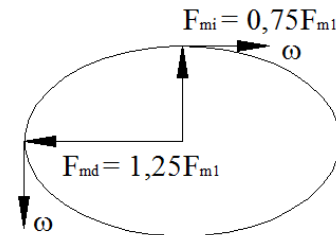

Fig. 5. The elliptic curve of the magnetizing forces MASF.

opposite direction.

The ellipse indicated in figure 5 is obtained at geometric summing of components of the direct and opposite successions.

## 6. THE CALCULATION OF MAGNETIC FIELD WITH THE APPLICATION OF FINITE ELEMENTS

The finite element method was applied based on the geometric dimensions of the engine with a single-phase on the stator for determining the distribution of magnetic field lines, and for determining the magnetic induction and respective values. Figure 6, a shows the view of the magnetic field produced by the stator winding  $W_{Ax}$  in idle mode. Variation curve of magnetic induction (fig. 6, b) is symmetric and contains harmonics of dental order.

The maximum value of magnetic induction in the air gap (fig. 6 c) is:

$$B_{m.mg} = \sqrt{2} \cdot B_n = \sqrt{2} \cdot 0,348 = 0,48 T ,$$

and does not differ essentially from that obtained in calculations.

$$\frac{B_{m.p}}{B_{m.mg}} = \frac{0,71}{0,48} = 1,48$$

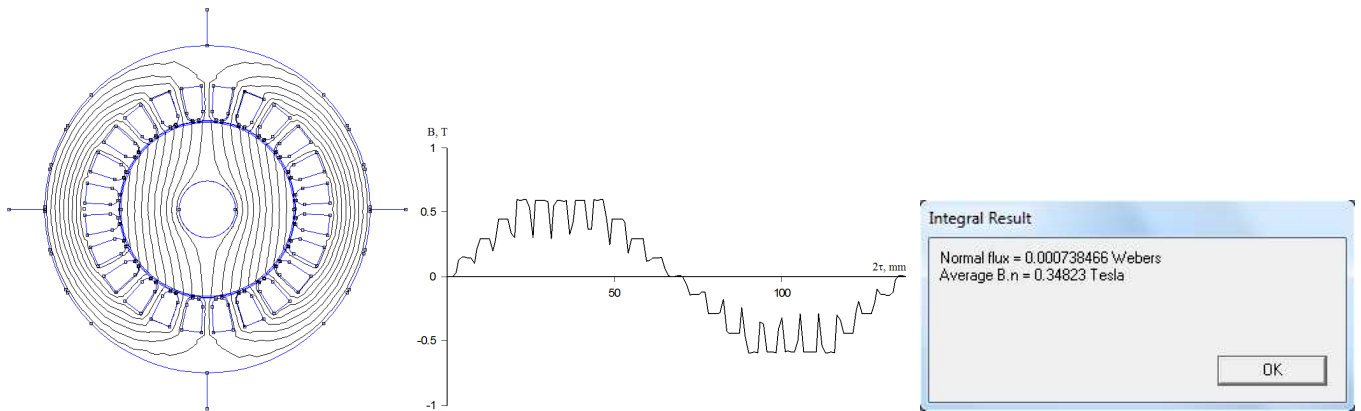

**Fig. 6.** The results of magnetic field calculation with FEMM application:

- a) distribution of magnetic lines;
- b) variation of magnetic induction curve in the air gap;
- c) the values of the flux and magnetic induction.

The magnetic flux lines are shifted in reference to vertical axis if shortcutting the  $W_{By}$  part of the stator winding (fig. 7 a).

The amplitude value of the magnetic induction in air gap is (fig. 7 b, c):

$$B_{m.p} = \sqrt{2} \cdot B_n = \sqrt{2} \cdot 0,5 = 0,71 T$$

The ratio between induction amplitudes is:

This asymmetry will contribute to start of single-phase engine.

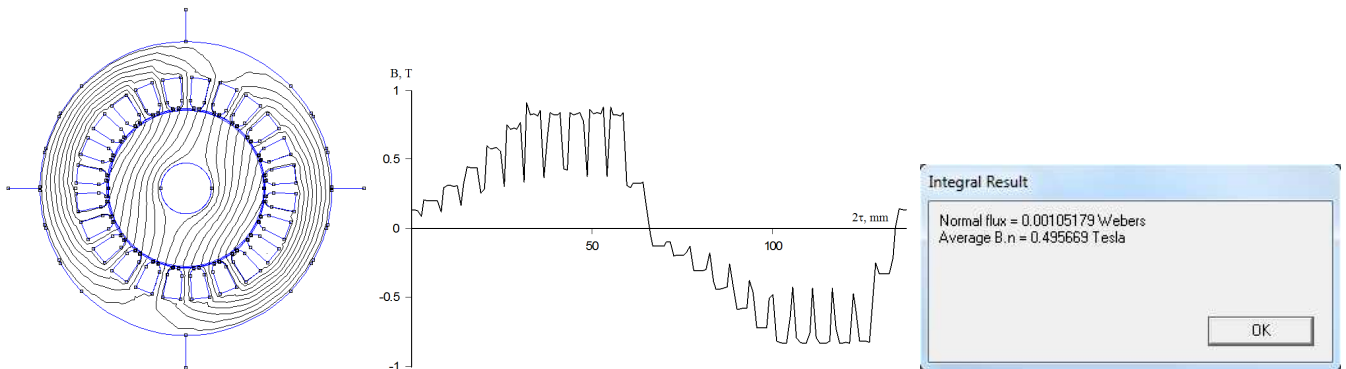

**Fig. 7.** The results of magnetic field calculation with FEMM application:

- a) the magnetic field picture at the shorting  $W_{By}$  ;
- b) variation of magnetic induction curve in the air gap;
- c) the values of the flux and magnetic induction.

## 7. CONCLUSIONS

✓ The realization and functioning of the the start of asynchronous engine with a single stator winding and shortcuted rotor has been theoretically and experimentally proved.

✓ The start is assured by shortcutting a part of the stator winding. This winding part is serially connected with the other part winding after start, thus saving auxiliary winding copper frequently used in practice.

✓ The theory elements applied for determining the electromotive voltage and magnetizing forces are given in the paper.

✓ The application of finite element theory has confirmed the results obtained in calculation.

## REFERENCES

- [1] **T. Ambros, V. Bejan , I. Onica** „La procede du demarage du moteur asynchrone single-phase”, Buletinul Institutului Politehnic din Iași 1995 - tom XLI.
- [2] **T. Ambros, A. Simion, L. Iazlovetchi** „Optimizarea procedeeului de pornire al motorului asincron monofazat”, Chișinău, Editura Tehnică, - vol.I, 1997.
- [3] **T. Ambros, A. Câmpeanu, C. Carabadjac** „Metode de compensare a succesiunii inverse în motoarele asincrone monofazate”, Prima Conferința Internațională de sisteme electromecanice, Chișinău, 1997.
- [4] **T. Ambros, M. Burduniuc, L. Iazlovetchi** „Pornirea și reglarea vitezei motoarelor asincrone monofazate”, Lucrările Conferinței Internaționale SIELMEN, Chișinău, 2001.
- [5] **T. Ambros, M. Burduniuc** „Noi posibilități de reglare a vitezei motoarelor asincrone monofazate”, Conferința Națională de Energetică, Chișinău, 19 – 21 octombrie 2000.

---

### About the authors

Lecturer **Marcel BURDUNIUC**  
Technical University of Moldova  
[marcburduniuc@gmail.com](mailto:marcburduniuc@gmail.com)

He graduated the Technical University of Moldova, Department of Electromechanics, Energetic Faculty in 1999. After graduation he worked ass engineer, assistant lecturer, senior lecturer at the Electromechanics Department of the Technical University of Moldova. He has published scientific papers and was teaching in the field of electric machines. The scientific activity is focused in the field of new construction of single-phase non traditional engines.